



INTERNATIONAL APPLICATION PUBLISHED UNDER THE PATENT COOPERATION TREATY (PCT)

<p>(51) International Patent Classification ⁶ : B01D 65/02</p>	<p>A1</p>	<p>(11) International Publication Number: WO 98/22204 (43) International Publication Date: 28 May 1998 (28.05.98)</p>
--	-----------	--

<p>(21) International Application Number: PCT/AU97/00791 (22) International Filing Date: 19 November 1997 (19.11.97) (30) Priority Data: PO 3777 21 November 1996 (21.11.96) AU (71) Applicant (for all designated States except US): MEMTEC AMERICA CORPORATION [US/US]; Suite 700, 9690 Deereco Road, Timonium, MD 21093 (US). (72) Inventors; and (75) Inventors/Applicants (for US only): JOHNSON, Warren [AU/AU]; 8 Scarborough Crescent, Bligh Park, NSW 2756 (AU). BECK, Thomas, William [AU/AU]; 31 Drummond Street, Windsor, NSW 2756 (AU). ROGERS, Peter [GB/GB]; 46 Morrellwood Drive, Belper, Derbyshire DE56 0JD (GB). (74) Agent: SHELSTON WATERS; 60 Margaret Street, Sydney, NSW 2000 (AU).</p>	<p>(81) Designated States: AL, AM, AT, AU, AZ, BA, BB, BG, BR, BY, CA, CH, CN, CU, CZ, DE, DK, EE, ES, FI, GB, GE, GH, HU, ID, IL, IS, JP, KE, KG, KP, KR, KZ, LC, LK, LR, LS, LT, LU, LV, MD, MG, MK, MN, MW, MX, NO, NZ, PL, PT, RO, RU, SD, SE, SG, SI, SK, SL, TJ, TM, TR, TT, UA, UG, US, UZ, VN, YU, ZW, ARIPO patent (GH, KE, LS, MW, SD, SZ, UG, ZW), Eurasian patent (AM, AZ, BY, KG, KZ, MD, RU, TJ, TM), European patent (AT, BE, CH, DE, DK, ES, FI, FR, GB, GR, IE, IT, LU, MC, NL, PT, SE), OAPI patent (BF, BJ, CF, CG, CI, CM, GA, GN, ML, MR, NE, SN, TD, TG). Published With international search report.</p>
--	--

(54) Title: MICROPOROUS MEMBRANE FILTRATION AND BACKWASHING PROCESS

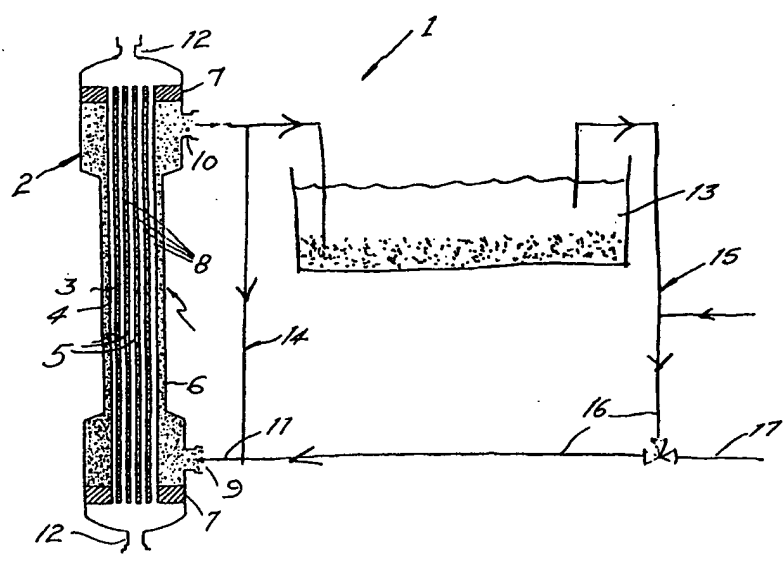

(57) Abstract

The invention relates to filtration processes of the kind using a microporous membrane, wherein feed containing contaminant matter is applied under pressure to a feed receiving surface of the membrane for passage therethrough and filtrate is withdrawn from the permeate side of the membrane. More particularly, the invention relates to systems that include means for backwashing the filter membranes and to a process and apparatus that enables control of the total volume of backwash fluid resulting therefrom, preferably with minimal detrimental effect on the process operation as a whole. This is achieved by selective reuse of the backwash fluid as part of the sweeping fluid used in the backwash operation and/or as part of the main feed.

FOR THE PURPOSES OF INFORMATION ONLY

Codes used to identify States party to the PCT on the front pages of pamphlets publishing international applications under the PCT.

AL	Albania	ES	Spain	LS	Lesotho	SI	Slovenia
AM	Armenia	FI	Finland	LT	Lithuania	SK	Slovakia
AT	Austria	FR	France	LU	Luxembourg	SN	Senegal
AU	Australia	GA	Gabon	LV	Latvia	SZ	Swaziland
AZ	Azerbaijan	GB	United Kingdom	MC	Monaco	TD	Chad
BA	Bosnia and Herzegovina	GE	Georgia	MD	Republic of Moldova	TG	Togo
BB	Barbados	GH	Ghana	MG	Madagascar	TJ	Tajikistan
BE	Belgium	GN	Guinea	MK	The former Yugoslav Republic of Macedonia	TM	Turkmenistan
BF	Burkina Faso	GR	Greece	ML	Mali	TR	Turkey
BG	Bulgaria	HU	Hungary	MN	Mongolia	TT	Trinidad and Tobago
BJ	Benin	IE	Ireland	MR	Mauritania	UA	Ukraine
BR	Brazil	IL	Israel	MW	Malawi	UG	Uganda
BY	Belarus	IS	Iceland	MX	Mexico	US	United States of America
CA	Canada	IT	Italy	NE	Niger	UZ	Uzbekistan
CF	Central African Republic	JP	Japan	NL	Netherlands	VN	Viet Nam
CG	Congo	KE	Kenya	NO	Norway	YU	Yugoslavia
CH	Switzerland	KG	Kyrgyzstan	NZ	New Zealand	ZW	Zimbabwe
CI	Côte d'Ivoire	KP	Democratic People's Republic of Korea	PL	Poland		
CM	Cameroon	KR	Republic of Korea	PT	Portugal		
CN	China	KZ	Kazakstan	RO	Romania		
CU	Cuba	LC	Saint Lucia	RU	Russian Federation		
CZ	Czech Republic	LI	Liechtenstein	SD	Sudan		
DE	Germany	LK	Sri Lanka	SE	Sweden		
DK	Denmark	LR	Liberia	SG	Singapore		
EE	Estonia						

- 1 -

**TITLE: MICROPOROUS MEMBRANE FILTRATION AND BACKWASHING
PROCESS**

FIELD OF THE INVENTION

The present invention relates to filtration processes of the kind using a
5 microporous membrane, wherein feed containing contaminate matter is applied under
pressure to a feed receiving surface of the membrane for passage therethrough and
filtrate is withdrawn from the permeate side of the membrane. More particularly, the
invention relates to systems that include means for backwashing the filter membranes.

BACKGROUND OF THE INVENTION

10 In all membrane filtration processes of the kind referred to above, contaminant
matter filtered from the feed continuously builds up on the feed receiving surface of the
membrane. This leads to a decrease in filtration efficiency and a corresponding decrease
in achievable permeate flux or an increase in operating pressure. Accordingly, it is
necessary to periodically clean the feed receiving surface of the membranes.

15 This is most commonly achieved with a frequent and generally regular
backwashing process, wherein a source of fluid under pressure is applied to the permeate
side of the microporous filter membrane so as to dislodge at least a portion of the
contaminant matter lodged within and/or on the feed receiving surface of the membrane.
The dislodged contaminant matter is then flushed out of the system by passing a
20 sweeping fluid over the feed receiving surface of the microporous membrane, the
resulting waste then being separately diverted from the system for subsequent disposal or
further treatment.

In small filtration units, this backwash comprising the sweeping fluid and contaminate matter is often disposed of by use directly for irrigation purposes or the like. However, in large scale membrane filtration plant, the problem of disposing of the significant volumes of backwash fluid is a major concern.

5 The preferred solution to date has been to provide backwash settling lagoons. The levels of the lagoons are controlled to some extent by natural evaporation and currently by feeding the supernatant from the lagoons back into the main feed on a continuous basis at a predetermined inclusion proportion of the feed flow.

10 However, recent tests have shown that this reprocessing of the backwash supernatant has a surprisingly adverse affect on the overall efficiency of the filtration system, resulting in significant increases in the rate at which the trans-membrane pressure (TMP) increases, which ultimately affects achievable permeate flow rates. Furthermore, simply ceasing to reuse any of the backwash is not desirable, as some means external to the filtration process will then be required to handle the increasing
15 volumes of backwash which would then add to the cost and complexity of the process.

It is an object of the present invention to provide a filtration and/or backwashing method and apparatus of the kind referenced above which overcomes or substantially ameliorates one or more of the above discussed disadvantages of the prior art or at least offers a useful alternative thereto.

20 DISCLOSURE OF THE INVENTION

According to a first aspect of the invention there is provided a method of backwashing microporous membranes which have been subjected to a filtration operation wherein feed containing contaminant matter is applied under pressure to a feed

- 3 -

receiving surface of the membrane for passage therethrough and filtrate is withdrawn from a permeate side of the membrane remote the feed receiving surface, said method comprising the steps of:

- (a) terminating the filtration operation by ceasing supply of feed under
5 pressure to said feed receiving surface of said membrane,
- (b) applying a source of fluid under pressure to said permeate side of the membrane such that said fluid under pressure passes in a reverse direction through said membrane so as to dislodge at least a portion of contaminant matter lodged within and/or
10 on said membrane,
- (c) passing a sweeping fluid past said feed receiving surface of said
membrane to flush out the dislodged contaminant matter and form a backwash liquid,
and
- (d) delivering the backwash liquid to a reservoir,
wherein at least a part of said sweeping fluid of step (c) comprises previously
15 accumulated backwash liquid from step (d).

Preferably, the backwash liquid used as sweeping fluid in step (c) comprises supernatant from a backwash settling lagoon.

This method is particularly suited to backwashing systems of the kind comprising a plurality of hollow elongate fibres having microporous walls which have been
20 subjected to a filtration operation wherein feed containing contaminant matter is applied under pressure to the exterior surface of said hollow fibres and filtrate is withdrawn from the ends of the lumens of the fibres, the fibres being contained within a shell or housing, said method then comprising the steps of:

- 4 -

- (a) terminating the filtration operation by ceasing supply of feed under pressure to said exterior surface of said membrane,
- (b) sealing the shell,
- (c) applying a source of fluid under pressure to said lumens such that said
5 fluid under pressure passes through said walls so as to dislodge at least a portion of contaminant matter lodged within and/or on said fibre walls,
- (d) passing a sweeping fluid past said exterior surface of said membrane to flush out the dislodged contaminant matter to form a backwash liquid, and
- (e) delivering the backwash liquid to a reservoir,
- 10 wherein at least a part of said sweeping fluid of step (d) comprises previously accumulated backwash liquid from step (c).

Desirably, the backwash liquid used as sweeping fluid comprises supernatant from a backwash settling lagoon.

Preferably, the supernatant from the settling lagoon is delivered to the feed
15 receiving surface of the membranes by direct injection into the feed line. It is presently believed that some form of plug flow will be achieved, albeit with a certain degree of mixing at the interfaces. In this manner the switching of the process to backwash sweeping mode can be triggered on a time or volume flow basis calculated from the point at which the supernatant is injected. Alternatively, presence of the backwash
20 supernatant at the membrane can be detected by monitoring the change in the trans-membrane pressure (TMP). In most cases the TMP will show a sharp increase when the supernatant reaches the membrane, as despite the settling process, there is still likely to

- 5 -

be a substantial quantity of fine particles that have remained in suspension in the supernatant.

According to a second aspect of the invention there is provided an apparatus for backwashing microporous membranes which have been subjected to a filtration

5 operation wherein feed containing contaminant matter is applied under pressure to a feed receiving surface of the membrane for passage therethrough and filtrate is withdrawn from a permeate side of the membrane remote the feed receiving surface, said apparatus comprising:

(a) means to terminate the filtration operation by cutting off supply of feed
10 under pressure to said feed receiving surface of said membrane;

(b) means to apply a source of fluid under pressure to said permeate side of the membrane such that said fluid under pressure passes in a reverse direction through said membrane so as to dislodge at least a portion of contaminant matter lodged within and/or on said membrane;

15 (c) means to deliver a sweeping fluid past said feed receiving surface of said membrane to flush out the dislodged contaminant matter and thereby form a backwash liquid;

(d) means to deliver the backwash liquid to a reservoir, and

(e) means to extract previously accumulated backwash liquid from said
20 reservoir for use as, or at least inclusion with, said sweeping fluid.

Preferably, the backwash liquid used as sweeping fluid comprises supernatant from a backwash settling lagoon.

- 6 -

The method and apparatus of the first and second aspects of the invention provides a convenient means of at least partially reusing and thereby controlling the volume of accumulated backwash waste, in a manner that also increases the overall efficiency of the filtration process when compared to the prior art method of

5 reprocessing the backwash by incorporation with the main feed.

According to a third aspect of the invention there is provided a method of operating a filtration system of the kind having a micro-porous membrane wherein feed containing contaminant matter is applied under pressure to a feed receiving surface of the membrane for passage therethrough and filtrate is withdrawn from a permeate side of

10 the membrane, the system further including means to backwash said membranes by applying a source of fluid under pressure to the permeate side of the micro-porous filter membrane so as to dislodge at least a portion of the contaminant matter lodged within and/or on said feed receiving surface, the dislodged contaminant matter then being flushed out of the system by passing a sweeping fluid over said feed receiving surface so

15 as to form a backwash liquid, said method of operation including the step of accumulating and recycling some or all of said backwash liquid as feed prior to storing the liquid in a settling lagoon or sending it to waste.

According to a fourth aspect of the invention there is provided a filtration system of the kind having a micro-porous membrane wherein feed containing contaminant

20 matter supplied under pressure to a feed receiving surface of the membrane the passage therethrough and filtrate is withdrawn from a permeate side of the membrane, the system further including means to backwash said membranes by applying a source of fluid under pressure to the permeate side of the micro-porous filter membrane so as to

- 7 -

dislodge at least a portion of the contaminant matter lodged within and/or on said feed receiving surface, said system further comprising means to pass a sweeping fluid over said feed receiving surface to flush the dislodged contaminant matter out of the system in the form of a backwash liquid, said system including means to accumulate and recycle as
5 feed some or all of said backwash liquid prior to storing the liquid in a settling lagoon or sending it to waste.

Preferably, the method and apparatus includes a step of, or means of, accumulating the backwash in a backwash reservoir and, prior to the scheduled backwashing step, switching from feed to recycling the backwash liquid from said
10 reservoir through the system until it has all been filtered.

More preferably, the backwash liquid is recycled a pre-determined number of times prior to finally being directed in its then more concentrated form to storage or waste.

Even more preferably, the method of operation includes the step of intermittently
15 backwashing with feed after a pre-determined number of steps of recycling the backwash liquid.

The method and apparatus of the third and fourth aspects of the invention similarly provide a convenient means of at least partially re-using and thereby controlling the volume of accumulated backwash waste. This not only increases the
20 overall yield but surprisingly has little, if any, detrimental effect on the overall efficiency of the filtration process.

In a further embodiment there is provided a system that incorporates both the modified backwash process of the first and second aspects of the invention, in

combination with the backwash recycling features of the third and fourth aspects of the invention.

All aspects of the invention are applicable to both dead end and cross-flow filtration operations.

5 BRIEF DESCRIPTION OF THE DRAWINGS

A preferred embodiment of both the first and second as well as the third and fourth aspects of the invention will now be described, by way of example only, with reference to the accompanying drawings in which:

Figure 1 is a schematic view of a filtration process in accordance with the first
10 and second aspects of the invention;

Figure 2 is a graph illustrating the variation in TMP with time for a prior art process that uses supernatant recycle into the main feed;

Figure 3 is a graph illustrating variation of TMP with time for a process according to the first and second aspects of the invention that does not use supernatant
15 recycle into the main feed;

Figure 4 is a graph illustrating variation of TMP with time for processing normal feed followed by supernatant.

Figure 5 is a schematic view of a prior art filtration process;

Figure 6 is a schematic view of a filtration process in accordance with the third and
20 fourth aspects of the invention; and

Figure 7 is a graph illustrating the variation in resistance with cumulative volume treated per unit membrane area.

PREFERRED EMBODIMENTS OF THE INVENTION

Referring to Figure 1, there is shown a schematic representation of a preferred form of the filtration process according to the first and second aspects of the invention.

The apparatus 1 comprises one or more filtration modules 2 which each include
5 filtration membranes in the form of a plurality of a hollow elongate fibres 3 having microporous walls 4 which define central passages or lumens 5. The fibres are housed within a shell 6 and sealed by means of two end plugs 7. These plugs serve to hold the hollow fibres in place and provide a barrier between the feed that is delivered to the exterior surfaces 8 of the fibres and the filtrate which flows out of the lumens.

10 An inlet port 9 and outlet port 10 are provided intermediate the plugs 7 for admission of feed from the feed line 11 to and through the module 2. Similarly, two ports 12 are also provided on the remote side of the plugs 7 for both extraction of the permeate or admission of pressurised backwashing fluid to the lumens.

The filtration system also includes a backwash liquid reservoir in the form of a
15 settling lagoon 13 to which backwash from the outlet port 10 is diverted. In the embodiment illustrated, a recycle circuit 14 is also included for recirculating the feed during normal cross-flow operation of the filtration module 2. However, the invention in all aspects is equally applicable to dead end filtration systems.

The system further comprises means shown generally at 15 to extract supernatant
20 from the reservoir, which in the preferred form is the settling lagoon 13 and direct it via piping 16 into the main feed line 11 for use in the backwash sweeping operation. A secondary delivery line 17 connects with the piping 16 for optional addition of some other form of suitable sweeping fluid.

- 10 -

In use, feed is directed under pressure to the inlet port 9 of module 2 via the main feed line 11, in a manner whereby at least a portion of the feed permeates through the walls 4 of the fibres 3, the resulting filtrate being extracted from ports 12. The excess cross-flow feed is diverted from outlet port 10 for recirculation through circuit 14.

5 Whilst the cross-flow through module 2 helps to limit the build-up of contaminant matter on the membrane walls 4, the gradual accumulation will nonetheless result in an increase in trans-membrane pressure (TMP). This results in a decrease in filtration efficiency and accordingly, a periodic backwashing process is required to remove the accumulated sludge to keep the process operating effectively.

10 During the backwashing process, the filtration operation is terminated by ceasing supply of feed under pressure to the shell 6. In one preferred process, gas is applied under high pressure to the lumens, in a manner whereby it is caused to pass through the fibre walls 4 in a reverse to normal direction to dislodge at least a portion of the contaminant matter lodged within and/or on the membrane. Flushing fluid is then
15 directed into the shell 6 via inlet 9 to flow past the external surface 8 of the membrane walls 4 to flush out the dislodged contaminant matter. The sweeping fluid and dislodged sludge is then diverted from outlet 10 to the settling lagoon 13.

The sweeping fluid in the process according to a preferred form of the first and second aspects of the invention comprises, at least in part, supernatant extracted from the
20 settling lagoon 13. The flushing fluid, comprising either supernatant alone or in combination with another liquid delivered at 17, is preferably injected directly into the main feed line 11, where it is believed that a certain degree of plug flow will occur. In

- 11 -

this regard plug flow is not critical, the fluid just needs to be circulated long enough to sweep out the solids.

In order to maximise the usage of supernatant and minimise the use of feed during this sweeping operation, the supernatant is directed into the main feed line in
5 advance of commencement of the backwashing process. The presence of the supernatant in the module can be established either on a time and flow rate basis where plug flow is assumed, or alternatively can be directly detected by monitoring the trans-membrane pressure (TMP) during the normal filtration process. In this regard it is expected that the presence of the supernatant will result in a rapid increase in the rate of change of TMP as
10 illustrated in Figure 4.

Referring next to Figure 2, there is shown a graph illustrating variation in TMP with time for prior art systems that incorporate backwash supernatant into the main feed. Each step of the graph represents a normal filtration period where the TMP gradually increases with time, each stage having a backwash operation therebetween. Figure 3
15 illustrates the variation of TMP with time for the same system in which the backwash supernatant is not added back to the main feed.

Figure 4 illustrates the effect of introducing backwash supernatant into the feed stream. TMP rise is very slow with no supernatant, but as soon as supernatant is added there is a sudden increase in TMP. This increase then triggers an automatic backwash.

20 As it can be seen by comparing the graphs, the add back of the backwash supernatant dramatically reduces the overall filtration efficiency of the process which is shown by the rate of TMP increase during filtration. It presently appears that use of the

- 12 -

supernatant as the backwashing fluid only, will result in an operation efficiency that is closer to that illustrated in Figure 3 than in the prior art process of Figure 2.

Turning next to the remaining figures 5 to 7, a preferred embodiment in accordance with the third and fourth aspects of the invention will now be described.

5 In this regard, figure 5 illustrates a standard filtration system with backwash facility. The system comprises, in its preferred form, a continuous micro-filtration (CMF) module 20 having a feed inlet port 21, a permeate outlet 22 and a backwash outlet 23.

10 Connected with the feed inlet port 21 is a feed pump 24 which draws feed from a break tank 25 via a control valve 26. The backwash outlet port 23 connects to a backwash tank 27 which itself has an outlet 28 that leads to waste.

In use, feed is directed into the CMF module 20 and the permeate is recovered from the outlet 22. As the contaminant matter gradually accumulates on the feed receiving surface of the membrane walls, a periodic backwashing process is required to
15 remove the accumulated sludge so as to keep the process operating effectively.

As discussed previously, during the backwashing process, the filtration operation is terminated by ceasing supply of feed under pressure to the module. In one preferred process, gas is applied under high pressure to the permeate side of the membrane in a manner whereby it is caused to pass through the membrane walls in reverse to normal
20 direction to dislodge at least a portion of the contaminant matter lodged within and/or on the membrane. Flushing fluid, normally in the form of extra feed, is then directed into the module to flow, not through the membrane, but past the feed receiving surface to flush out the dislodged contaminant matter and thereby form the backwash fluid. The

- 13 -

backwash fluid is then directed from outlet 23 to the backwash tank 27. From the tank the backwash fluid is then subsequently diverted to waste which in some installations, may comprise a settling lagoon which may also include supernatant recycle in accordance with the prior art.

5 Turning next to figure 6, there is shown the system of figure 5 modified in accordance with the third and fourth aspects of the present invention. Where appropriate, like reference numerals have been used to denote corresponding features.

The modified system includes means 30 to divert the backwash fluid from the backwash tank 25 to the feed inlet port 21 of the CMF module 20. In the embodiment
10 illustrated, this includes a booster pump 31. The system also includes a waste outlet 32 down stream of the booster pump 31.

In use, the system is operated to process feed, such as river water, in the manner described above. However, just prior to operating the periodic backwashing process, the feed is switched to backwash fluid feed until all the backwash fluid in the backwash tank
15 25 has been filtered. After this step the backwash operation is continued as for the standard system described above. In the embodiment tested to date, once the backwash has been filtered about 10 times it is sent to waste and the next backwash conducted entirely with feed and the process repeated from here on.

Preliminary trials have been conducted to compare systems using recycled
20 backwash (unit 2) with those using a standard backwash arrangement (unit 1), the results of which are set out below:

Average Feed Water Conditions

Feed type	Hawkesbury River Water
Suspended Solids (mg/L)	3.2
Turbidity (ntu)	2
Average Temperature (°C)	13

Trial Running Conditions & Results		
	Unit 1 Standard	Unit 2 Modified
No. Backwash Recycles	0	10
Module no. and type	38543 M10C	38544 M10C
Instantaneous Flow (L/hr)	2,500	2,500
Filtration interval (min)	22	22
Initial TMP (kPa)	105	95
Final TMP (kPa)	190	178
TMP Rise (kPa)	85	83
Initial Resistance (m^{-1})	4.4×10^{12}	4.0×10^{12}
Final Resistance (m^{-1})	8.0×10^{12}	7.5×10^{12}
Resistance Rise (m^{-1})	3.6×10^{12}	3.5×10^{12}
Volume Throughput (L)	191000	191000

As can be seen from reference to figure 7, the method and apparatus of the third and fourth aspects of the invention provide a means of increasing the overall yield by partially re-using the backwash fluid, thereby simultaneously controlling the volume of

- 15 -

accumulated backwash waste, with surprisingly little affect on the overall efficiency of the filtration process. More specifically, figure 7 shows that even with 10 recycles, the performance of the unit is virtually no different (in fact slightly better in this example) than the unit operated with no recycle (conventional method). This is thought to arise in part from the fact that the backwash fluid will contain a particle distribution that will be the same as the particles within the cake of accumulated contaminants on the feed receiving surface of the membranes. It is considered that this distribution of particles to include large particles (which would not be present in, say, supernatant from a settling lagoon) helps to prevent the filters clogging. Also the particles are filtered onto an already existing filter cake and are thus more readily backwashed off the surface than if applied directly to a clean membrane.

Finally, it will be appreciated that the backwash liquid from the backwash tank 25 identified in respect of the third and fourth aspects of the invention can readily be used as part of the sweeping fluid referred to in respect of the first and second aspects of the invention, alone or in combination with the step of recycling part of this backwash fluid as feed.

Although the invention has been described with reference to specific embodiments, it will be appreciated by those skilled in the art that the invention may be embodied in many other forms.

CLAIMS

1. A method of backwashing microporous membranes which have been subjected to a filtration operation wherein feed containing contaminant matter is applied under pressure to a feed receiving surface of the membrane for passage therethrough and
5 filtrate is withdrawn from a permeate side of the membrane remote the feed receiving surface, said method comprising the steps of:
- (a) terminating the filtration operation by ceasing supply of feed under pressure to said feed receiving surface of said membrane,
 - (b) applying a source of fluid under pressure to said permeate side of the
10 membrane such that said fluid under pressure passes in a reverse direction through said membrane so as to dislodge at least a portion of contaminant matter lodged within and/or on said membrane,
 - (c) passing a sweeping fluid past said feed receiving surface of said
15 membrane to flush out the dislodged contaminant matter and form a backwash liquid, and
 - (d) delivering the backwash liquid to a reservoir,
wherein at least a part of said sweeping fluid of step (c) comprises previously accumulated backwash liquid from step (d).
2. A method of backwashing microporous membranes as claimed in claim 1 wherein
20 the backwash liquid used as a sweeping fluid in step (c) comprises supernatant from a backwash settling lagoon.
3. A method of backwashing microporous membranes in membrane filtration systems of the kind comprising a plurality of hollow elongate fibres having microporous walls

- 17 -

which have been subjected to a filtration operation wherein feed containing contaminant matter is applied under pressure to the exterior of said hollow fibres and filtrate is withdrawn from the ends of the lumens of the fibres, the fibres being contained within a shell or housing, said method comprising the steps of:

- 5 (a) terminating the filtration operation by ceasing supply of feed under pressure to said exterior surface of said membrane,
- (b) sealing the shell,
- (c) applying a source of fluid under pressure to said lumens such that said fluid under pressure passes through said walls so as to dislodge at least a portion of
- 10 contaminant matter lodged within and/or on said fibre walls,
- (d) passing a sweeping fluid past said exterior surface of said membrane to flush out the dislodged contaminant matter to form a backwash liquid, and
- (e) delivering the backwash liquid to a reservoir,
- wherein at least a part of said sweeping fluid of step (d) comprises previously
- 15 accumulated backwash liquid from step (c).

4. A method of backwashing microporous membranes as claimed in claim 3 wherein the backwash liquid used as a sweeping fluid comprises supernatant from a backwash settling lagoon.

5. A method of backwashing microporous membranes according to claim 2 or claim

20 4 wherein the supernatant from the settling lagoon is delivered to the feed receiving surface of the membranes by direct injection into the feed line.

- 18 -

6. A method of backwashing microporous membranes according to claim 5 wherein switching of the process to backwash sweeping mode is triggered on a time or volume flow basis calculated from the point at which the supernatant is injected.
7. A method of backwashing microporous membranes according to claim 5 wherein
5 the switching of the process to backwash sweeping mode is triggered by monitoring the change in trans-membrane pressure (TMP) due to the presence or absence of the supernatant.
8. An apparatus for backwashing microporous membranes which have been
10 subjected to a filtration operation wherein feed containing contaminant matter is applied under pressure to a feed receiving surface of the membrane for passage therethrough and filtrate is withdrawn from a permeate side of the membrane remote the feed receiving surface, said apparatus comprising:
- (a) means to terminate the filtration operation by cutting off supply of feed under pressure to said feed receiving surface of said membrane;
 - 15 (b) means to apply a source of fluid under pressure to said permeate side of the membrane such that said fluid under pressure passes in a reverse direction through said membrane so as to dislodge at least a portion of contaminant matter lodged within and/or on said membrane;
 - (c) means to deliver a sweeping fluid past said feed receiving surface of said
20 membrane to flush out the dislodged contaminant matter and thereby form a backwash liquid;
 - (d) means to deliver the backwash liquid to a reservoir, and

- 19 -

(e) means to extract previously accumulated backwash liquid from said reservoir for use as, or at least inclusion with, said sweeping fluid.

9. An apparatus for backwashing microporous membranes according to claim 8 wherein the backwash liquid used as a sweeping fluid comprises supernatant from a
5 backwash settling lagoon.

10. A method of operating a filtration system of the kind having a micro-porous membrane wherein feed containing contaminant matter is applied under pressure to a feed receiving surface of the membrane for passage therethrough and filtrate is withdrawn from a permeate side of the membrane, the system further including means to
10 backwash said membranes by applying a source of fluid under pressure to the permeate side of the micro-porous filter membrane so as to dislodge at least a portion of the contaminant matter lodged within and/or on said feed receiving surface, the dislodged contaminant matter then being flushed out of the system by passing a sweeping fluid over said feed receiving surface so as to form a backwash liquid, said method of
15 operation including the step of accumulating and recycling some or all of said backwash liquid as feed prior to storing the liquid in a settling lagoon or sending it to waste.

11. A method of operating a filtration system according to claim 10 including the step of accumulating the backwash in a backwash reservoir and, prior to the scheduled backwashing step, switching from feed to recycling the backwash liquid from said
20 reservoir through the system until it has all been filtered.

12. A method of operating a filtration system according to claim 10 or claim 11 wherein the backwash liquid is recycled a pre-determined number of times prior to finally being directed in its then more concentrated form to storage or waste.

- 20 -

13. A method of operating a filtration system according to any one of claims 10 to 12 including the step of intermittently backwashing with feed after a pre-determined number of steps of recycling the backwash liquid.
14. A filtration system of the kind having a micro-porous membrane wherein feed
5 containing contaminant matter supplied under pressure to a feed receiving surface of the membrane the passage therethrough and filtrate is withdrawn from a permeate side of the membrane, the system further including means to backwash said membranes by applying a source of fluid under pressure to the permeate side of the micro-porous filter
10 membrane so as to dislodge at least a portion of the contaminant matter lodged within and/or on said feed receiving surface, said system further comprising means to pass a sweeping fluid over said feed receiving surface to flush the dislodged contaminant matter out of the system in the form of a backwash liquid, said system including means to accumulate and recycle as feed some or all of said backwash liquid prior to storing the liquid in a settling lagoon or sending it to waste.
- 15 15. A filtration system according to claim 14 including means for accumulating the backwash in a backwash reservoir and, prior to the scheduled backwashing step, switching from feed to recycling the backwash liquid from said reservoir through the system until it has all been filtered.
16. A filtration system according to claim 14 or claim 15 including means for
20 permitting the backwash liquid to be recycled a pre-determined number of times prior to finally be directed in its then more concentrated form to storage or waste.

- 21 -

17. A filtration system according to any one of claims 14 to 16 including means to facilitate intermittent backwashing with feed after a pre-determined number of steps of recycling the backwash liquid.
18. A method of operating a filtration system according to any one of claims 10 to 13
5 incorporating a method of backwashing microporous membranes in accordance with any one of claims 1 to 7.
19. A filtration system according to claims 14 to 17 including an apparatus for backwashing microporous membranes in accordance with claim 8 or claim 9.

1/6

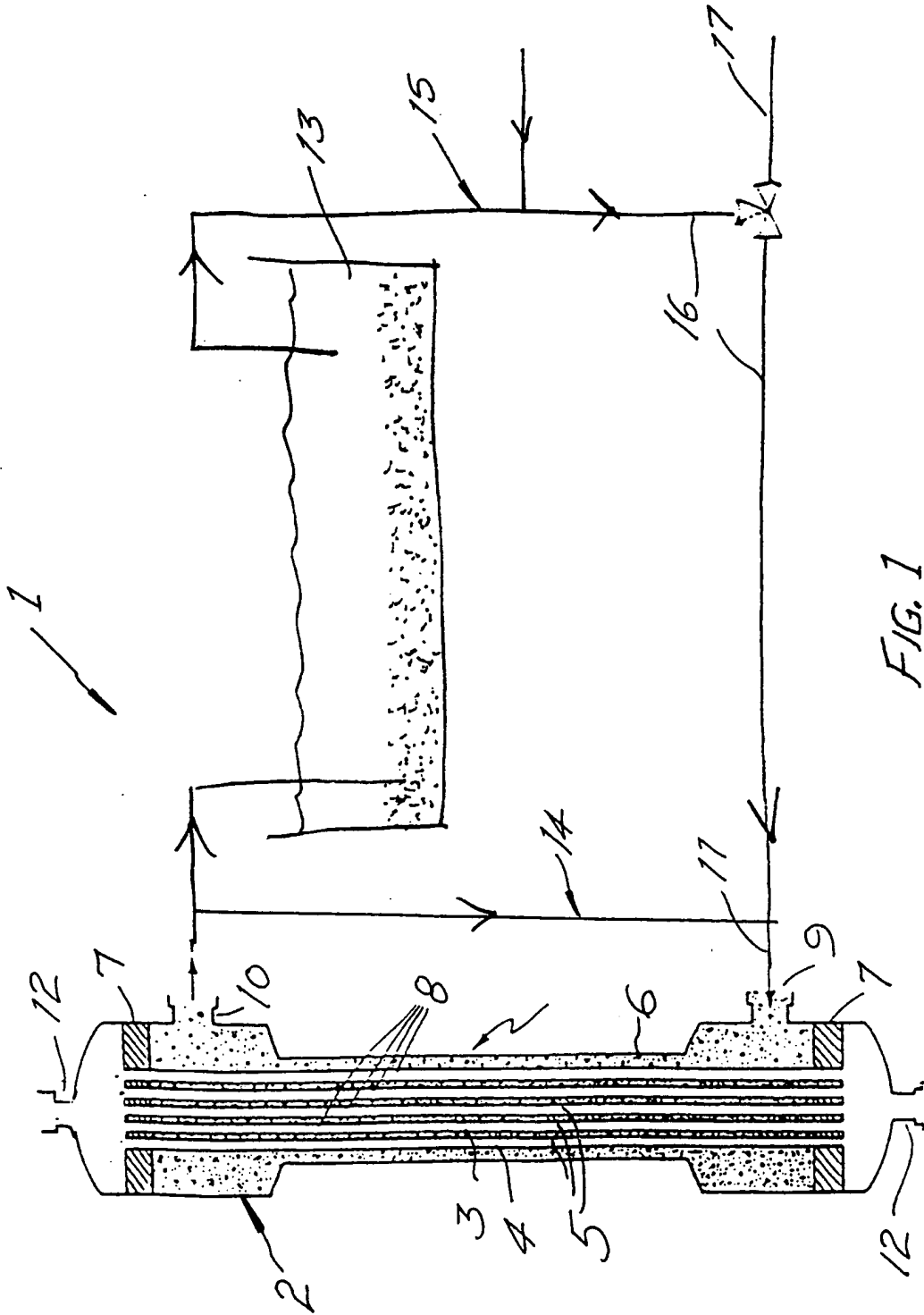

FIG. 1

TMP .vs. TIME WITH 20% BACKWASH SUPERNATANT RECYCLE

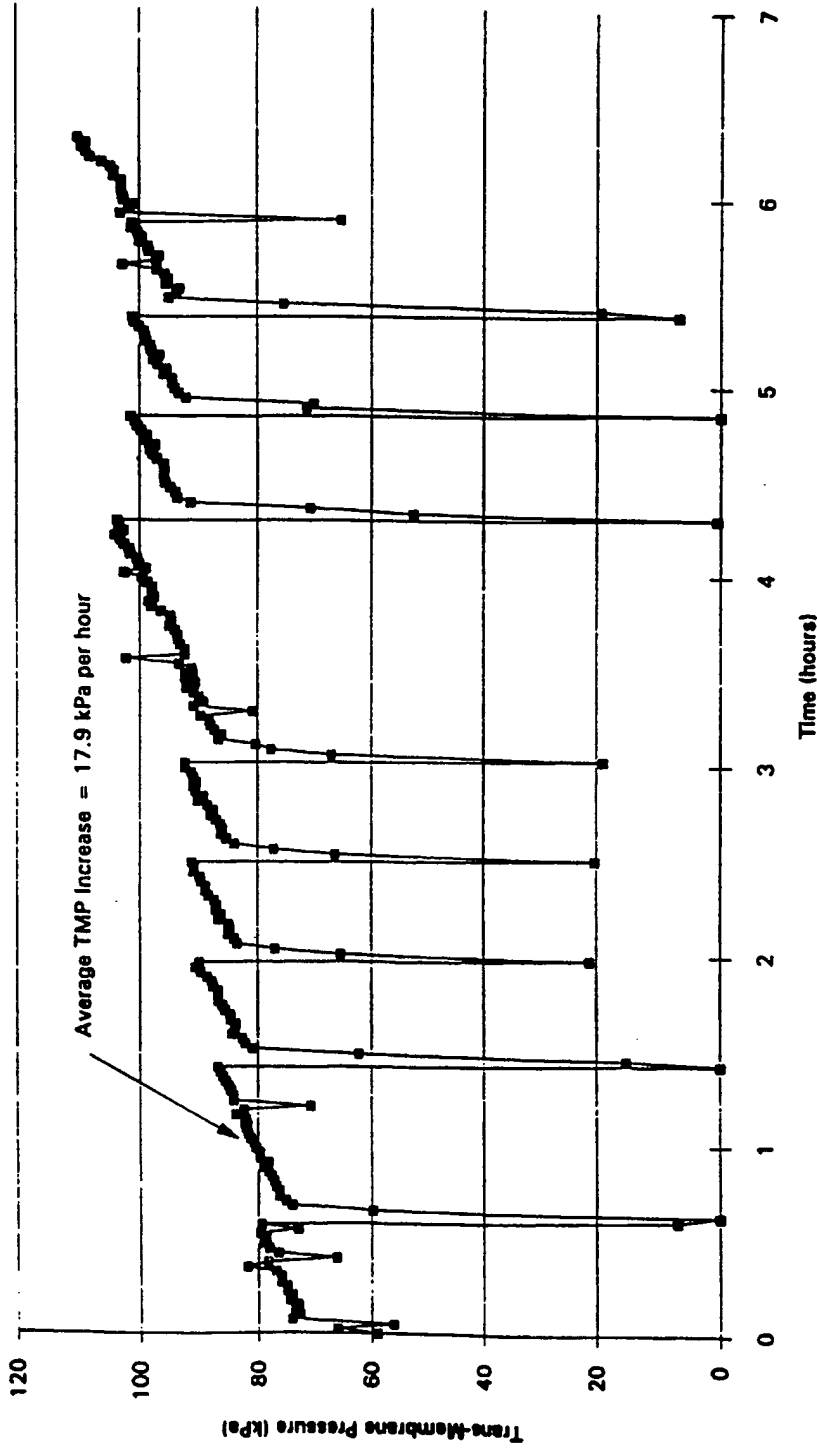

FIG. 2

TMP .vs. TIME WITHOUT BACKWASH SUPERNATANT RECYCLE

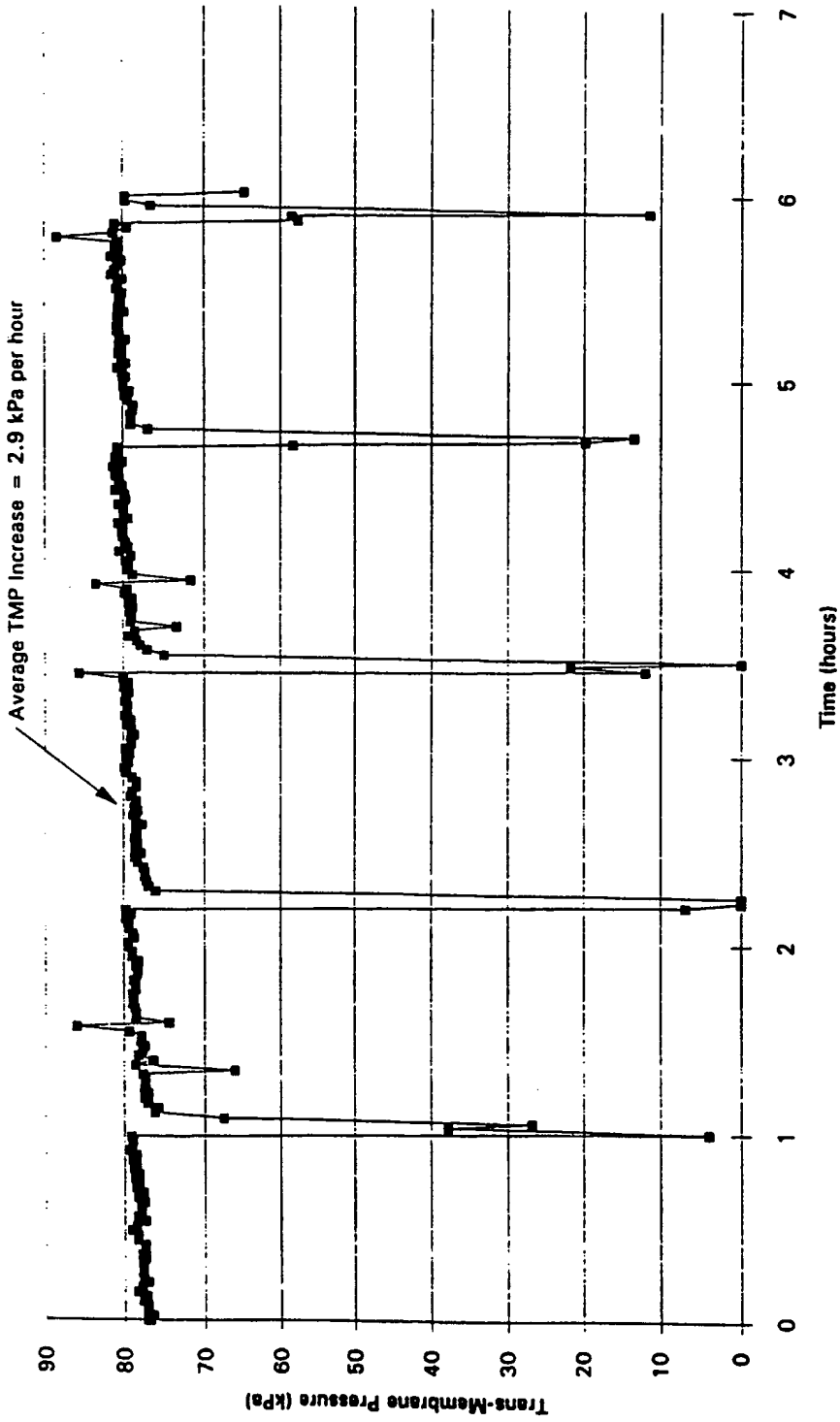

FIG. 3

TMP (kPa) versus Time (minutes)

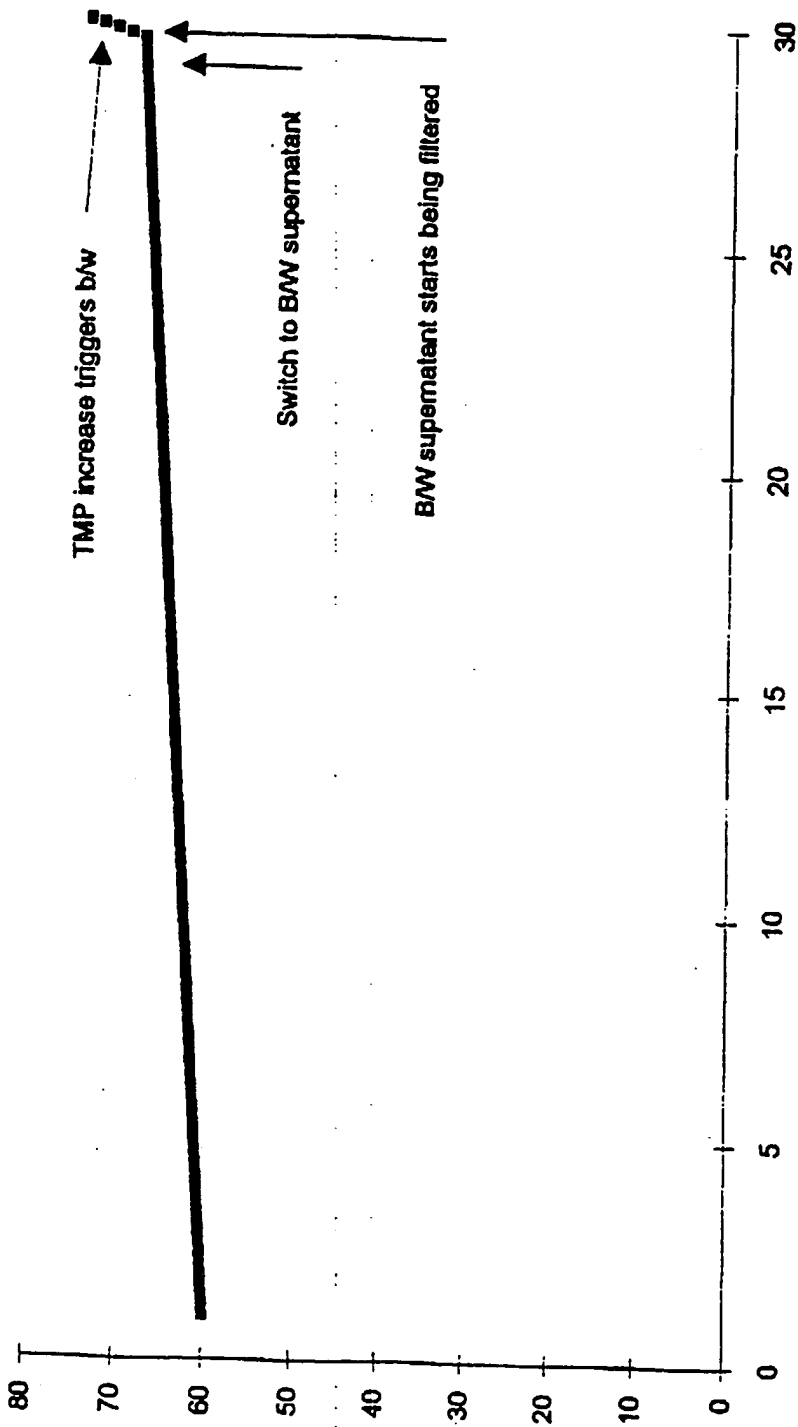

FIG. 4

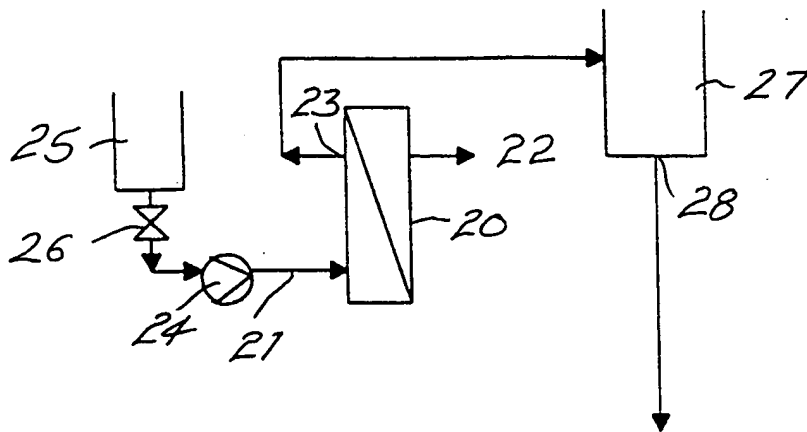

FIG. 5

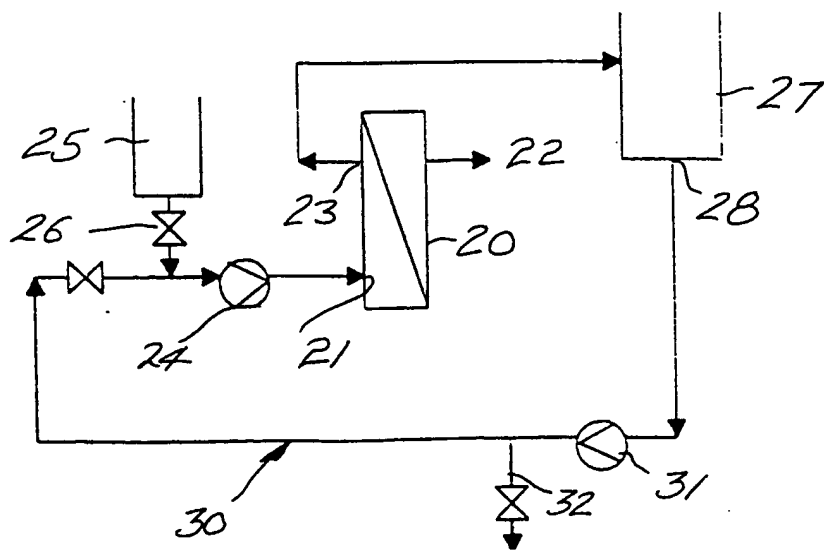

FIG. 6

Backwash Strategies Trial: 10 Backwash Recycles
Flow 2500 L/hr

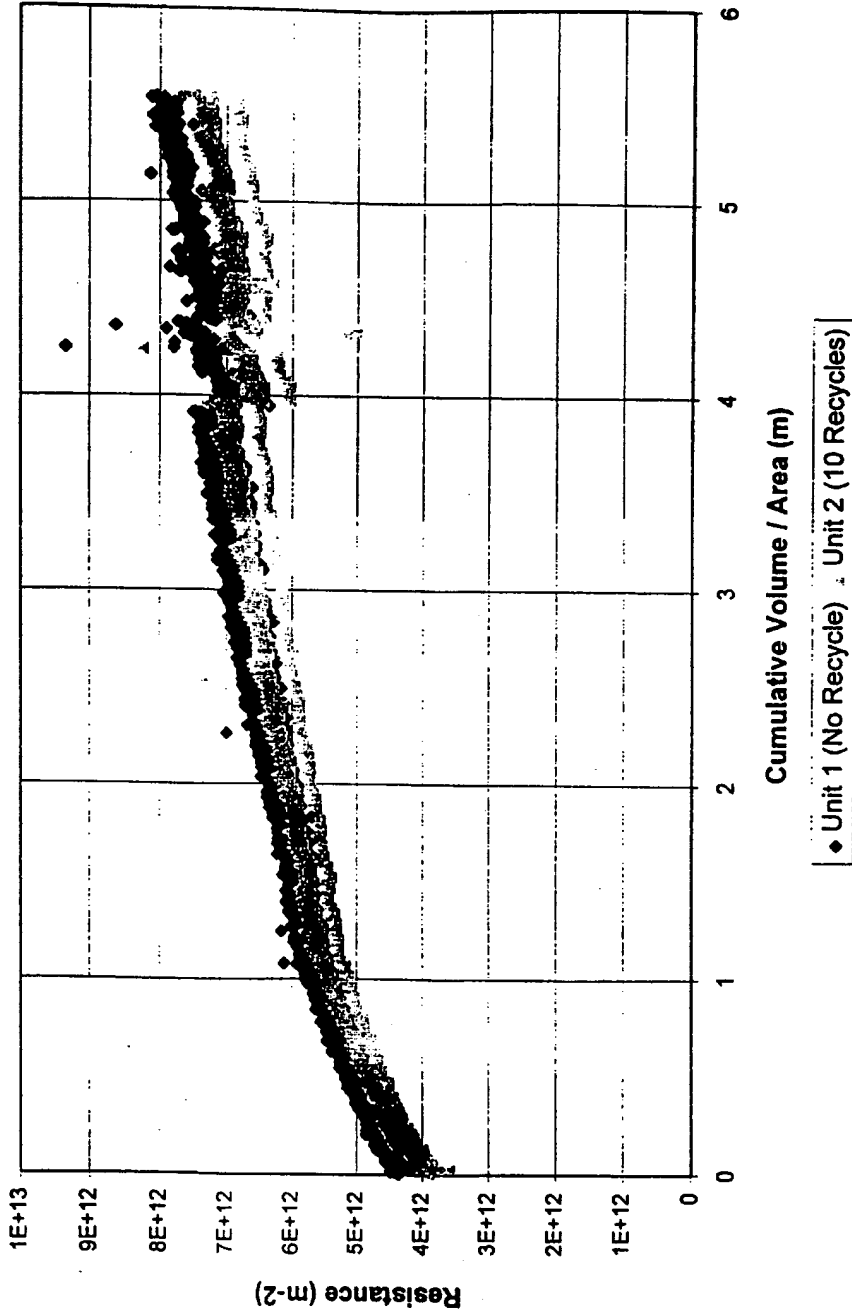

FIG. 7

INTERNATIONAL SEARCH REPORT

International Application No.
PCT/AU 97/00791

A. CLASSIFICATION OF SUBJECT MATTER		
Int Cl ⁶ : B01D 65/02		
According to International Patent Classification (IPC) or to both national classification and IPC		
B. FIELDS SEARCHED		
Minimum documentation searched (classification system followed by classification symbols) IPC ⁶ : B01D 65/02, IPC ⁴ : B01D 13/00, 13/01		
Documentation searched other than minimum documentation to the extent that such documents are included in the fields searched AU: IPC as above		
Electronic data base consulted during the international search (name of data base and, where practicable, search terms used) (WPAT, JAPIO) + KW (BACKWASH)		
C. DOCUMENTS CONSIDERED TO BE RELEVANT		
Category*	Citation of document, with indication, where appropriate, of the relevant passages	Relevant to claim No.
X,Y	WO, A, 9607470 (MEMTEC LIMITED) 14 March 1996 See whole document	(1-10), 14, 18, 19
X,Y	WO, A, 8605116 (MEMTEC LIMITED) 12 September 1986 See whole document	(1-10), 14, 18, 19
Y	DERWENT Abstract Accession No. 95-307326/40 JP, A, 07204474 (KURITA WATER IND LTD) 8 August 1995	(1-10), 14, 18, 19
A	WO, A, 8605705 (MEMTEC LIMITED) 9 October 1986	
<input checked="" type="checkbox"/> Further documents are listed in the continuation of Box C <input checked="" type="checkbox"/> See patent family annex		
* Special categories of cited documents: "A" document defining the general state of the art which is not considered to be of particular relevance "E" earlier document but published on or after the international filing date "L" document which may throw doubts on priority claim(s) or which is cited to establish the publication date of another citation or other special reason (as specified) "O" document referring to an oral disclosure, use, exhibition or other means "P" document published prior to the international filing date but later than the priority date claimed "T" later document published after the international filing date or priority date and not in conflict with the application but cited to understand the principle or theory underlying the invention "X" document of particular relevance; the claimed invention cannot be considered novel or cannot be considered to involve an inventive step when the document is taken alone "Y" document of particular relevance; the claimed invention cannot be considered to involve an inventive step when the document is combined with one or more other such documents, such combination being obvious to a person skilled in the art "&" document member of the same patent family		
Date of the actual completion of the international search 21 January 1998		Date of mailing of the international search report 30 JAN 1998
Name and mailing address of the ISA/AU AUSTRALIAN INDUSTRIAL PROPERTY ORGANISATION PO BOX 200 WODEN ACT 2606 AUSTRALIA Facsimile No.: (02) 6285 3929		Authorized officer <i>M Olley</i> M. OLLEY Telephone No.: (02) 6283 2143

INTERNATIONAL SEARCH REPORT

International Application No.
PCT/AU 97/00791

C (Continuation) DOCUMENTS CONSIDERED TO BE RELEVANT		
Category*	Citation of document, with indication, where appropriate, of the relevant passages	Relevant to claim No.
A	WO, A, 8800494 (MEMTEC LIMITED) 28 January 1988	
A	EP, A, 669159 (DIC DEGRÉMONT KK) 30 August 1995	
A	EP, A, 678326 (STORK FRIESLAND B.V.) 25 October 1995	
A	WO, A, 9429007 (BUCHERGUYER AG) 22 December 1994	
A	DERWENT Abstract Accession No. 92-214442/26 jp,a,04145930 (TOSHIBA CERAMICS CO) 19 may 1992	

INTERNATIONAL SEARCH REPORT
 Information on patent family members

International Application No.
 PCT/AU 97/00791

This Annex lists the known "A" publication level patent family members relating to the patent documents cited in the above-mentioned international search report. The Australian Patent Office is in no way liable for these particulars which are merely given for the purpose of information.

Patent Document Cited in Search Report		Patent Family Member					
WO	9607470	AU	34661/95	CA	2199356	EP	779835
WO	8605116	AU	55847/86	EP	213157	US	4931186
		US	5024762	CN	86104888		
WO	8605705	AU	56923/86	EP	216876	US	4816160
WO	8800494	AU	77066/87	DK	1312/88	EP	289523
		US	4935143				
EP	669159	JP	7236818				
EP	678326	NL	9400647				
WO	9429007	AU	67195/94	CA	2141846	CZ	9500351
		EP	663852	HU	71041	NZ	266122
		PL	307394				
END OF ANNEX							